



Thank you for purchasing the SUP825J Multi-function process calibrator. This manual describes the configuration, operation and maintenance of the SUP825J Multi-function process calibrator. To ensure correct use, please read this manual thoroughly and have a clear understanding of the calibrator before operation.

Notes

- This manual should be read by the end user.
- UK SAMPSON EQUIPMENT INTERNATIONAL LIMITED warrants goods of its manufactures being free of defective materials and faulty workmanship. If warranted goods are returned to UK SAMPSON EQUIPMENT INTERNATIONAL LIMITED or its representatives during the period of coverage of one year, UK SAMPSON EQUIPMENT INTERNATIONAL LIMITED will repair or replace without charge any defective items. UK SAMPSON EQUIPMENT INTERNATIONAL LIMITED guarantees all the goods with life maintenance.
- Specifications or other contents of this manual are subject to change without prior notice for improvement. When there is a possibility that the foregoing change may result in serious accident or injury, UK SAMPSON EQUIPMENT INTERNATIONAL LIMITED will give notice in advance.
- Every effort has been made in the preparation of this manual to ensure the accuracy of its contents. However, should you have any questions or find any errors, please contact your nearest customer service.
- Do not modify this. UK SAMPSON EQUIPMENT INTERNATIONAL LIMITED assumes no liability for any loss or damage, direct or indirect, caused by the user.
- Copying or reproducing all or any part of the contents of this manual without the permission of UK SAMPSON EQUIPMENT INTERNATIONAL LIMITED.

I

Symbol Definitions

	<p>Warning</p> <p>This symbol indicates a hazardous situation, which, if not avoided, could result in death, serious injury or property damage.</p>
	<p>Caution</p> <p>This symbol indicates a potentially hazardous situation, which, if not avoided, might result in damage to the SUP825J Multi-function process calibrator or surroundings.</p>



Warning

- Do not apply more than the rated voltage, as marked on the SUP825J Multi-function process calibrator, between the jacks, or between any jacks and earth ground. Maximum for all jacks is 30V, 24mA.
- Do not operate the SUP825J Multi-function process calibrator in the presence of flammable liquids or vapors, since operation in such environments constitutes a safety hazard.
- Never disassemble, remodel, modify, or repair this SUP825J Multi-function process calibrator. Otherwise malfunction, electric shock, or failure may result.
- Never use the SUP825J Multi-function process calibrator if it is found damaged or deformed when unpacked. Otherwise a fire, malfunction, or failure may result.
- Disconnect the power and discharge all high voltage capacitors in the equipment under test before testing resistances.
- Inspect the test leads for damaged insulation or exposed metal. Check test lead continuity. Replace damaged test leads before using the SUP825J Multi-function process calibrator.
- Do not use the SUP825J Multi-function process calibrator if it operates abnormally. Select the proper function for your measurement. Connect the test leads to the flashing jacks.
- Charge the battery as soon as there is a low battery indication on the display.
- Do not use the SUP825J Multi-function process calibrator with any part of the case or cover removed.
- Do not measure a voltage source when the test leads are plugged into the current jacks.

III



Caution

- When you turn on the SUP825J Multi-function process calibrator, you had better measure known voltage to confirm it can be operated normally.
- Make sure the battery door is closed before you operate the SUP825J Multi-function process calibrator.
- Remove test leads from the SUP825J Multi-function process calibrator before you open the battery door.
- When using the leads, keep your fingers away from the lead contacts. Keep your fingers behind finger guards on the leads.
- Dispose the SUP825J Multi-function process calibrator as an industrial waste.

CONTENTS

1	Introduction.....	1
2	Standard Equipments.....	1
3	Getting started.....	5
4	SUP825J Multi-function process calibrator Summary.....	7
4.1	Jacks.....	7
4.2	Keys.....	9
4.3	Display.....	12
5	Using Measure Mode.....	13
5.1	Measuring Voltage (Upper Display).....	13
5.2	Measuring Current (Upper Display).....	13
5.3	Measure current with loop power.....	13
5.4	Measuring Voltage (Lower Display).....	16
5.5	Measuring Resistance.....	16
5.6	Measuring Frequency.....	18
5.7	Counting pulse.....	18
5.8	Measuring Temperature with TC.....	20
5.9	Measuring Temperature with RTDs.....	20
6	Using Source Mode.....	25
6.1	Sourcing Voltage.....	25
6.2	Sourcing Current.....	25
6.3	Sourcing Resistance.....	27
6.4	Sourcing Frequency.....	27
6.5	Simulating Thermocouples.....	29
6.6	Simulating RTD.....	29
6.7	Ramping and Stepping the Output.....	31
6.8	Simulating Transmitter.....	31
7	Cold Junction.....	33
8	Switching Temperature Unit.....	33
9	Calibration.....	34
9.1	Equipments Required.....	34
9.2	Entry and Exit.....	34
9.3	Calibration.....	35

V

9.3.1	Calibrating Sourcing.....	35
9.3.2	Calibrating Measurement.....	36
9.3.3	Calibrating Cold Junction.....	36
10	Clear Function.....	38
10.1	Clear of Measuring Voltage.....	38
10.2	Clear of Sourcing Voltage.....	39
10.3	Clear of Measuring with TC.....	40
10.4	Clear of Resistance and RTD.....	40
10.5	Clear of Sourcing TC.....	41
11	Calibrating a Transmitter.....	41
12	Maintenance.....	43
13	Specifications.....	44
14	Optional Parts.....	50

1 Introduction

SUP825J Multi-function process calibrator is a handheld, battery-powered instrument that measures and sources a variety of parameters. It can be widely applied in industrial fields and laboratories. The summary functions of the Multi-function process SUP825J Multi-function process calibrator are shown in Table2-1. In addition to these functions, the SUP825J Multi-function process calibrator has other features as follows:

- A split-screen display. The upper display shows measure parameters while the lower one shows measure or source parameters;
- Counting pulse function;
- Calibration functions;
- Auto ramping and auto stepping;
- Manual and automatic cold junction compensating;
- Clear function;
- Temperature unit switching
- Auto flashing jacks;
- Backlight LCD;
- Battery gauge.

2 Standard Equipments

The items listed below and shown in Figure2-1 are included in your Counting pulse function. If the Counting pulse function is damaged or something is missing, contact our service center immediately. To order the optional parts, see '14 Optional Parts'.

- Counting pulse function
- Counting pulse function Users Manual
- Alligator clips (one set)
- Test probes (one set)
- Test leads (one set)
- Battery charge

- 4 AA rechargeable batteries

Table2-1 Summary of Source and Measure Functions

Function	Source/Measure		
	Measure	Measure	Source
V DC	(0~30)V	(0~20)V	(0~10)V
mV DC	(0~100)mV	(0~100)mV	(0~100)mV
mA DC	(0~24)mA	—	(0~24)mA
Current loop	(0~24)mA	—	—
Transmitter signal	—	—	(0~24)mA
Counting pulse	—	0~99999	—
Frequency	—	(1~10k)Hz	(1~5k)Hz
Resistance	—	(0~3200) Ω	(15~3200) Ω
TC(Thermocouple)	J, K, T, E, R, S, B, N		
RTD (Resistance- Temperature Detector)	—	Cu50 Pt100(385)	

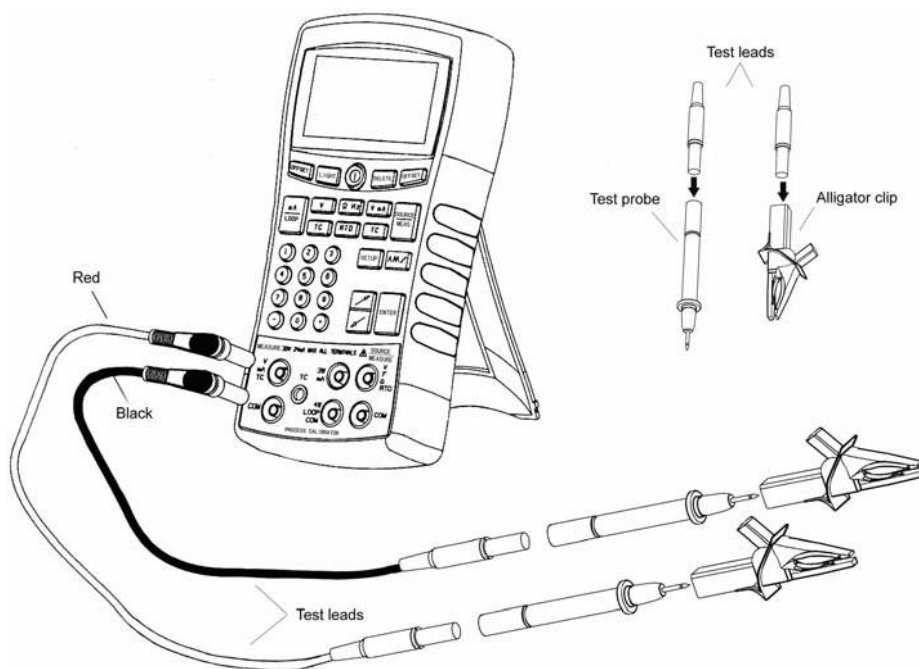







Figure2-1 Standard Equipment

3 Getting started

When you first unpack the SUP825J Multi-function process calibrator, you will need to charge the battery. After reinstalling the battery, please perform the test of sourcing and measuring V DC as follows, it will make be easier to understand the instructions in the rest of the manual.

- (1) Press  to turn on the SUP825J Multi-function process calibrator.
- (2) Clearing offset of measuring V DC in the upper display and sourcing V DC in the lower display according to '10 Clear Function'.
- (3) Press  to select DC voltage.
- (4) Press  for Source mode. Press  to select sourcing V DC.
- (5) According to the flashing jacks , connect the SUP825J Multi-function process calibrator's voltage output to its voltage input as Figure3-1 shows.
- (6) Enter the desired output value by press numeric keys on the keypad and press  to begin sourcing V DC.
- (7) The SUP825J Multi-function process calibrator is simultaneously sourcing V DC and measuring V DC. You should see the measurement readings in the upper display, and the active source value in the lower display.

5

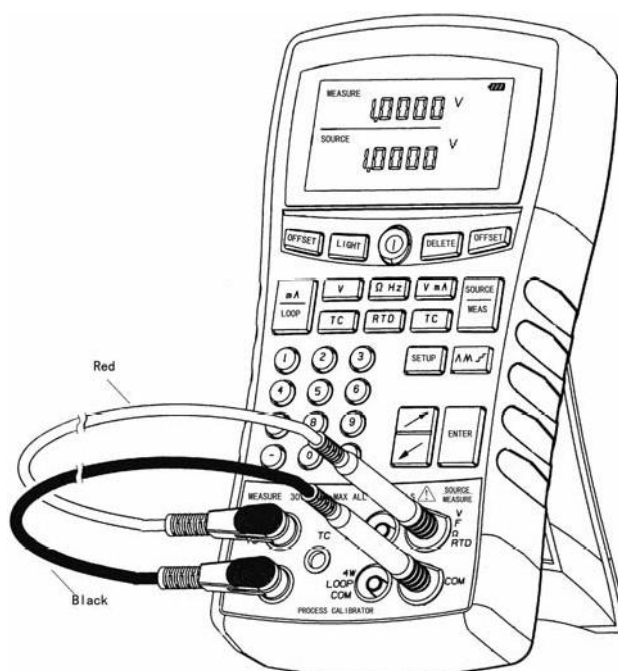

Figure3-1 Source/Measure V DC

4 SUP825J Multi-function process calibrator Summary

4.1 Jacks

Figure4-1 shows the SUP825J Multi-function process calibrator Source/Measure jacks and Table4-1 explains their use.

Auto flash jacks will guide you to the correct connecting. For example, after you select to measure voltage in lower display, ⑥ and ⑦ in Figure4-1 will flash, and then you can put the test leads into the jacks correctly.

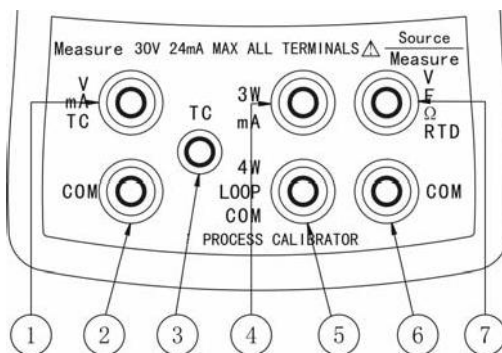

Figure4-1 Source /Measure Jacks

7

Table4-1 Measure/Source Jacks

No.	Function	Description
①②	Jacks for measuring voltage, current and TC.	The measurement reading is shown in the upper display.
③	Jack for measuring TC cold junction.	Automatic cold junction.
④⑤	Jacks for sourcing current.	The source reading is shown in the lower display.
⑤⑥	Jacks for simulating transmitter.	The source reading is shown in the lower display.
⑥⑦	Jacks for measuring or sourcing voltage, frequency, resistance, counting pulse, TC and 2-wire RTD.	The measurement or source reading is shown in the lower display.
④⑥⑦	Jacks for measuring 3-wire resistance and RTD.	The measurement reading is shown in the lower display.
④⑤⑥⑦	Jacks for measuring 4-wire resistance and RTD.	The measurement reading is shown in the lower display.

4.2 Keys

Figure4-2 shows the SUP825J Multi-function process calibrator keys and Table4-2 explains their functions.

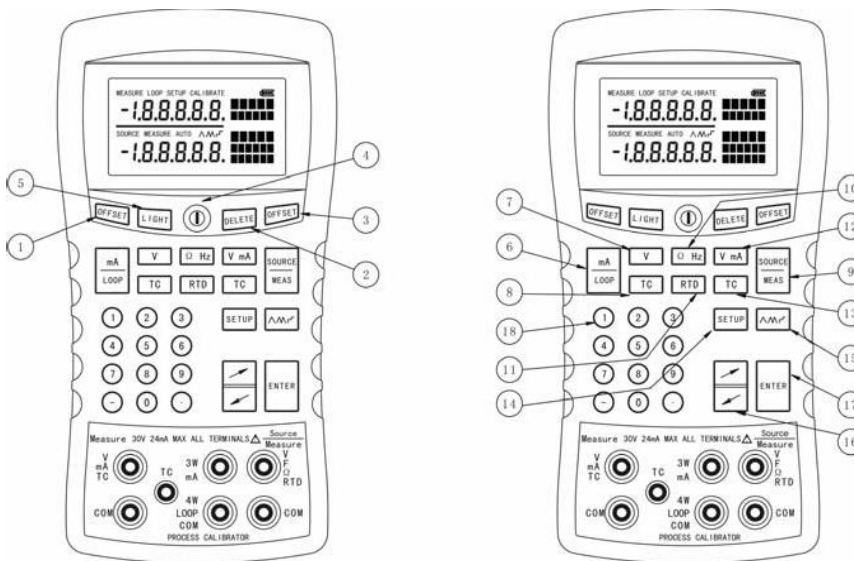



Figure4-2 Keys

Table4-2 Keys Functions

No.	Key	Description
①	OFFSET	Clears offset of Measure mode in the upper display.
②	DELETE	Deletes the last digit of input data; Clears the counting pulse.
③	OFFSET	Clears offset of Measure and Source modes in the lower display.
④	I	Turns the power on and off.
⑤	LIGHT	Turns the backlight on and off.
⑥	mA LOOP	Selects the mA or mA Loop measurement function in the upper display.
⑦	V	Selects voltage measurement function in the upper display.
⑧	TC	Selects TC measurement function in the upper display.
⑨	SOURCE MEAS	Switches between Measure and Source modes in the lower display.

No.	Key	Description	
		Measure mode	Source mode
⑩	Ω Hz	Selects resistance or frequency measurement functions.	Selects resistance or frequency sourcing functions.
⑪	RTD	Selects RTD measurement function.	Selects RTD sourcing function.
⑫	V mA	Selects voltage or mA measurement functions.	Selects voltage sourcing function.
⑬	TC	Selects TC measurement function.	Selects TC sourcing function.
⑭	SETUP	Switches temperature unit, enters and exits Setup mode, sets cold junction temperature, and so on.	
⑮		Cycles through: ^ Slow repeating 0%~100%~0% ramp; M Fast repeating 0%~100%~0% ramp; r Repeating 0%~25%~50%~75%~100%~0% step.	
⑯		Increases the source value, least significant digit +1; Decreases the source value, least significant digit -1.	
⑰	ENTER	Terminates a numeric entry, when setting a source value; Begin/Stop counting pulse; Confirm your choice in a list.	
⑱	Numeric keypad	Used whenever a numeric entry is required.	

4.3 Display

Figure4-3 shows the elements of a typical display.

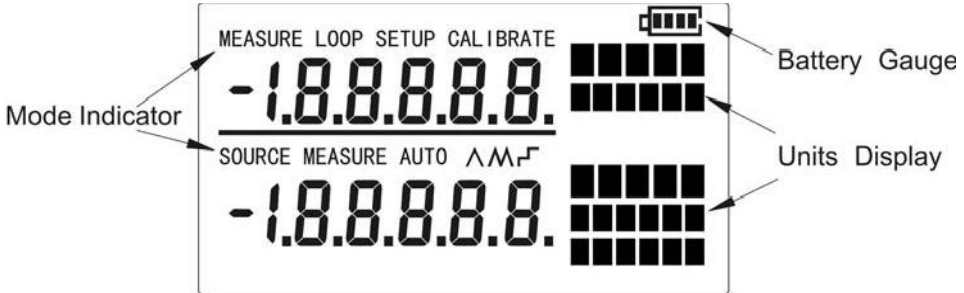



Figure4-3 Elements of a Typical Display

5 Using Measure Mode

5.1 Measuring Voltage (Upper Display)

To measure the voltage, proceed as follows.

- (1) Press  until the upper display shows "mV" or "V".
- (2) Connect the test leads as shown in Figure5-1.

You should see the measurement readings in the upper display.

5.2 Measuring Current (Upper Display)

To measure the current, proceed as follows:

- (1) Press  until the upper display shows "MEASURE".
- (2) Connect the test leads as shown in Figure5-2.

You should see the measurement readings in the upper display.

5.3 Measure current with loop power

- (1) Press  until the upper display shows "MEASURE LOOP".
- (2) Connect the test leads to the transmitter current loop jacks as shown in Figure5-3.
- (3) The SUP825J Multi-function process calibrator supplies an internal 24V loop power.

You should see the measurement readings in the upper display.

 **CAUTION:** Never short two test leads in "MEASURE LOOP" mode.

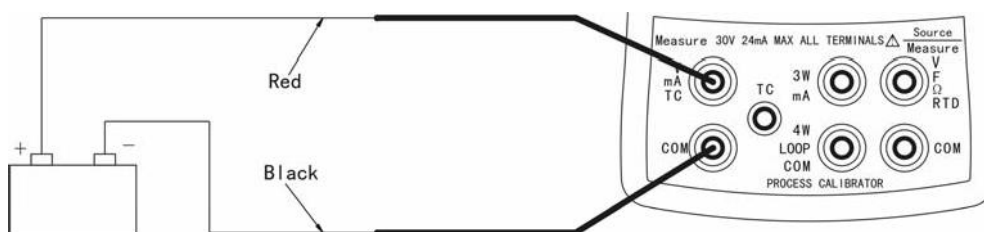

Figure5-1 Measuring Voltage (Upper Display)

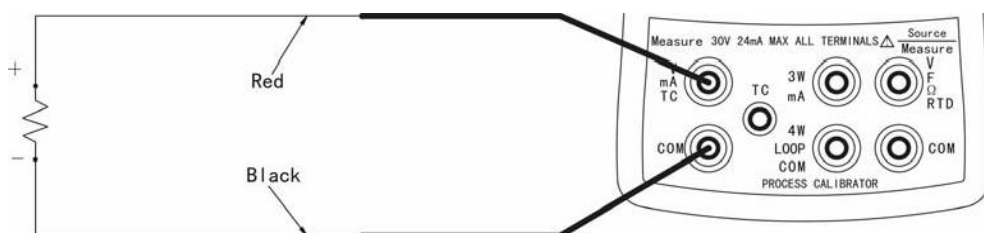

Figure5-2 Measuring Current (Upper Display)

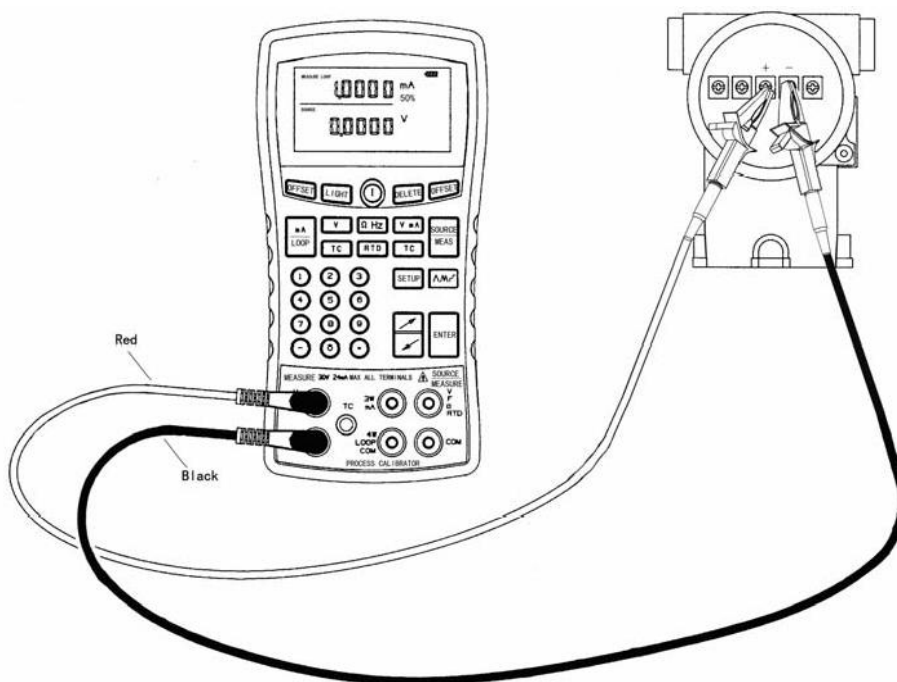



Figure5-3 Connections for Supplying Loop Power

15

5.4 Measuring Voltage (Lower Display)



To measure the voltage, proceed as follows:

- (1) Press  until the lower display shows "MEASURE".
- (2) Press  to select DC voltage until the display shows "V" or "mV".
- (3) Connect the test leads as shown in Figure5-4.

You should see the measurement readings in the lower display.

5.5 Measuring Resistance

To measure the resistance, proceed as follows:

- (1) Press  until the lower display shows "MEASURE".
- (2) Press  to select resistance until the display shows "Ω".
- (3) Connect the test leads as shown in Figure5-5.

You should see the measurement readings in the lower display.

 **CAUTION:** Clear of resistance before measuring, according to '10.4 Clear of Resistance and RTD'.

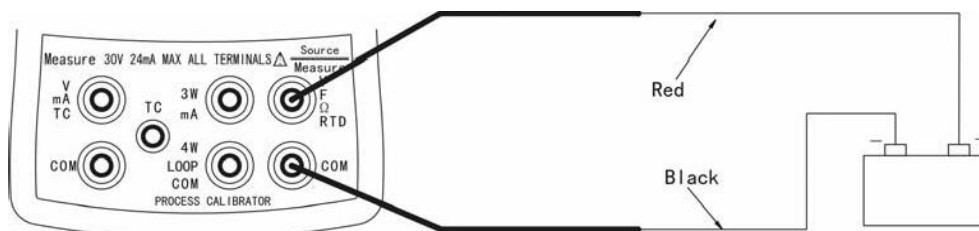

Figure5-4 Measuring Voltage (Lower Display)

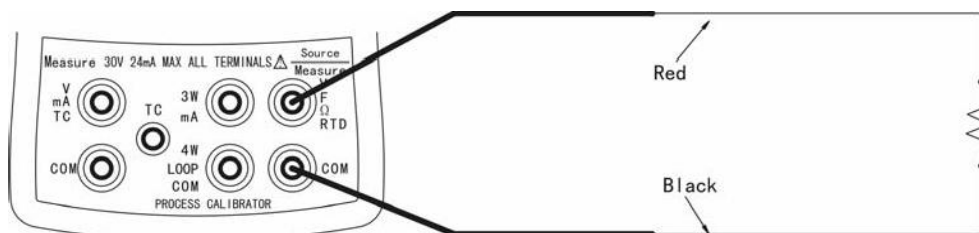



Figure5-5 Measuring Resistance

17

5.6 Measuring Frequency



The function of Measuring Frequency is only applicable to SUP825J Multi-function process calibrator. To measure the frequency, proceed as follows:



- (1) Press  until the lower display shows "MEASURE".
- (2) Press  to select frequency until the display shows "Hz".
- (3) Connect the test leads as shown in Figure5-6.

You should see the measurement readings in the lower display.

5.7 Counting pulse

The function of counting pulse is only applicable to SUP825J Multi-function process calibrator. To use this function, proceed as follows:

- (1) Press  until the lower display shows "MEASURE".
- (2) Press  to select counting pulse until the display shows "COUNT".
- (3) Connect the test leads as shown in Figure5-7.

- (4) Press  to start counting, and press  again to stop counting. Press  to clear the result.

Pulse counting is shown in the lower display, the range is 0~99999. The display shows "-OL" when input overflows. The time is displayed by seconds at the bottom right corner.

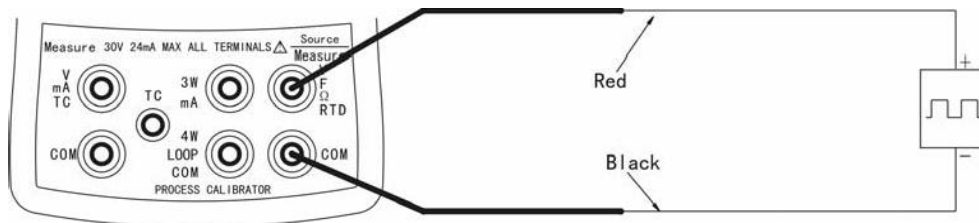

Figure5-6 Measuring Frequency

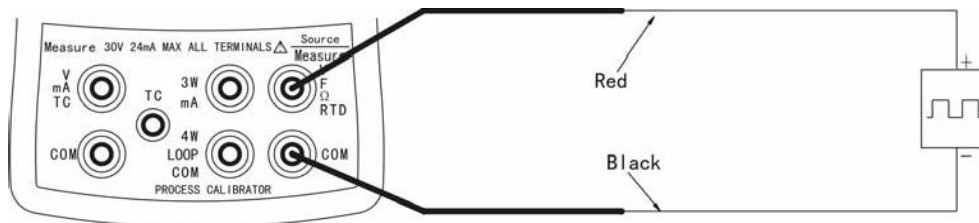



Figure5-7 Connection of Counting Pulse

19



5.8 Measuring Temperature with TC

The SUP825J Multi-function process calibrator supports eight types of standard TC. Table5-1 summarizes the ranges and characteristics of the supported TC. Change the unit of temperature according to '8 Switching Temperature Unit'.

To measure temperature using a TC, proceed as follows:

- (1) Press  until the lower display shows "measure".
- (2) Press  to select the desired thermocouple type.
- (3) Connect the leads as shown in Figure5-8.



You should see the measurement readings in the lower display.

 **CAUTION:** Please pay attention to the cold junction temperature, and if necessary, press  to set the cold junction temperature manually.

5.9 Measuring Temperature with RTDs

The SUP825J Multi-function process calibrator accepts RTD types shown in Table5-2. RTDs are characterized by their resistance at 0°C, which is called the "ice point" or R_0 . The most common R_0 is 100Ω. The SUP825J Multi-function process calibrator accepts RTD measurement input in 2-, 3-, or 4-wire connections, with the 3-wire connection the most common. Change the unit of temperature according to '8 Switching Temperature unit'

To measure temperature using an RTD input, proceed as follows:

- (1) Press  until the lower display shows "MEASURE".
- (2) Press  to select the desired RTD type.
- (3) Press  to select a 2-, 3-, or 4-wire mode. Connect the test leads as shown in Figure5-9.

i CAUTION: Clear of RTD before measuring, according to '10.4 Clear of Resistance and RTD'.

Table5-1 Thermocouple Types Accepted

Type	Specified Range
J	(-200~1200)°C
K	(-200~1370)°C
T	(-200~400)°C
E	(-100~950)°C
R	(-20~1750)°C
S	(-20~1750)°C
B	(600~1800)°C
N	(-200~1300)°C

Table5-2 RTD Types Accepted

Type	Ice Point (R ₀)	α	Range
Cu50	50Ω	0.00428Ω/°C	(-50~150)°C
Pt100(385)	100Ω	0.00385Ω/°C	(-200~800)°C
Pt100(3916)	100Ω	0.003916Ω/°C	(-200~510)°C
Pt200(385)	200Ω	0.00385Ω/°C	(-200~630)°C
Pt500(385)	500Ω	0.00385Ω/°C	(-200~630)°C
Pt1000(385)	1000Ω	0.00385Ω/°C	(-200~630)°C

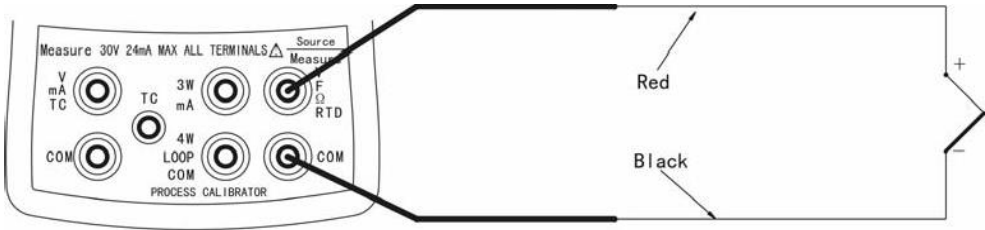

Figure5-8 Measuring Temperature with a TC

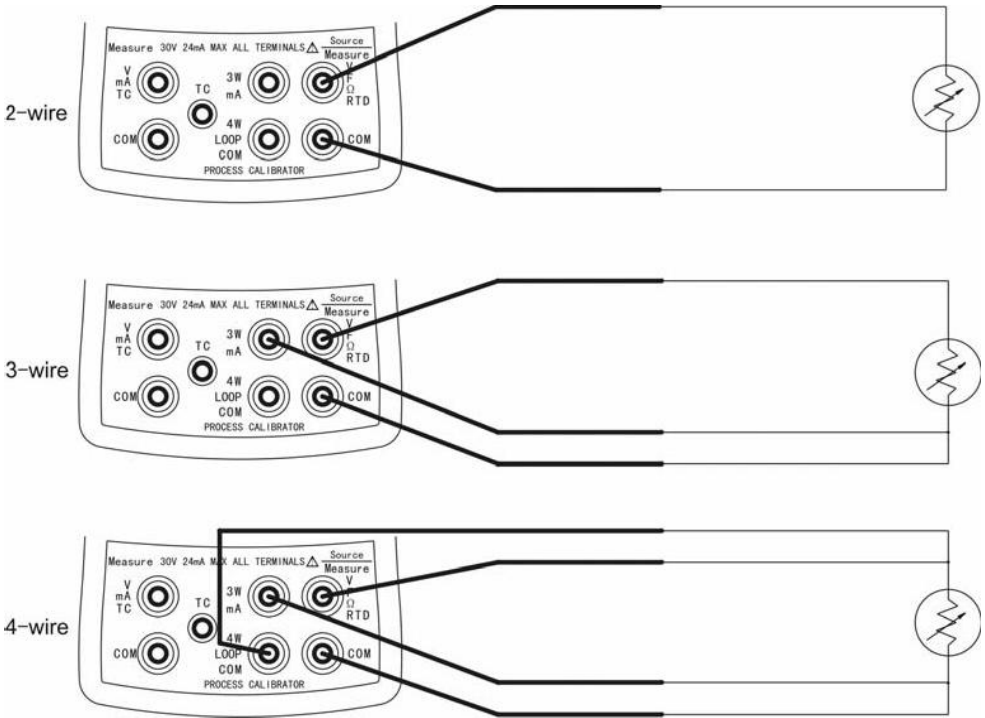



Figure5-9 Measuring Temperature with an RTD

6 Using Source Mode

In Source mode, the SUP825J Multi-function process calibrator generates calibrated signals for testing and calibrating process instruments, supplies voltages and resistances, and simulates the electrical output of RTD and TC temperature sensors. These signals are sourced and shown in the lower display.

6.1 Sourcing Voltage



To select a voltage sourcing function, proceed as follows:

- (1) Press  until the lower display shows "SOURCE".
- (2) Press  to select voltage until the display shows "V" or "mV".
- (3) Connect the test leads as shown in Figure6-1.
- (4) Enter the desired output value by pressing numeric keypads

and press .

6.2 Sourcing Current

The function of Sourcing Current is only applicable to SUP825J Multi-function process calibrator. To select a current sourcing function, proceed as follows:

- (1) Press  until the lower display shows "SOURCE".
- (2) Press  to select current until the display shows "mA".
- (3) Connect the test leads as shown in Figure6-2.
- (4) Enter the desired output value by pressing numeric keypads

and press .

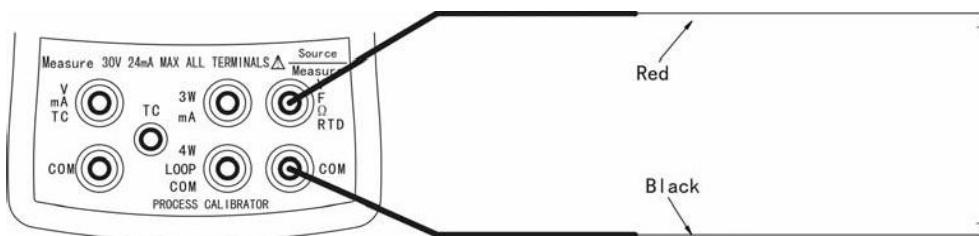

Figure6-1 Voltage Sourcing Connections

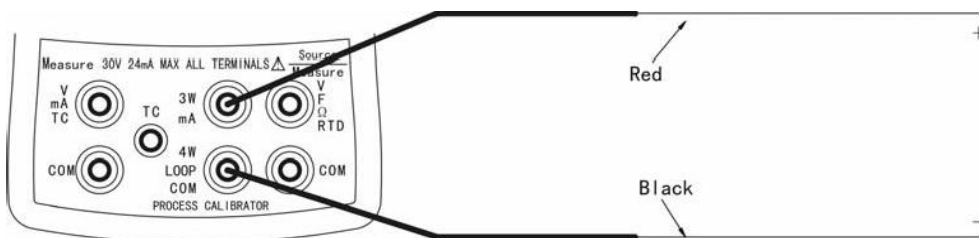



Figure6-2 Current Sourcing Connections

6.3 Sourcing Resistance

To select a resistance sourcing function, proceed as follows:



- (1) Press  until the lower display shows "SOURCE".
- (2) Press  to select resistance until the display shows "Ω".
- (3) Connect the test leads as shown in Figure6-3.
- (4) Enter the desired output value by pressing numeric keypads

and press 

i CAUTION: Clear of resistance before sourcing according to '10.4 Clear of Resistance and RTD'.

6.4 Sourcing Frequency

The function of Sourcing Frequency is only applicable to SUP825J Multi-function process calibrator. To select a frequency sourcing function, proceed as follows:

- (1) Press  until the lower display shows "SOURCE".
- (2) Press  to select frequency until the display shows "Hz".
- (3) Connect the test leads as shown in Figure6-4.
- (4) Enter the desired output value by pressing numeric keypads

and press 

Amplitude of the output frequency is displayed at the bottom right

corner. You can press  to adjust the amplitude. The step of amplitude is 0.5V, and the range is (0-8)V.

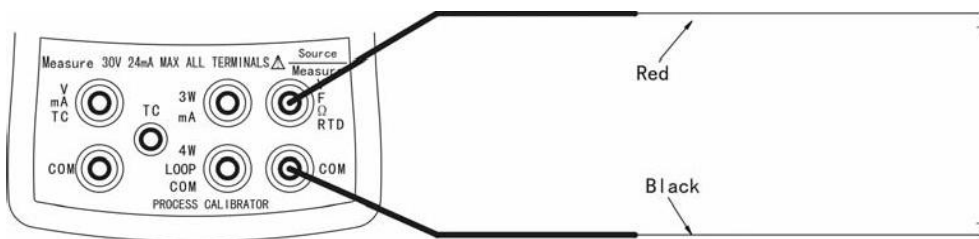

Figure6-3 Resistance Sourcing Connections

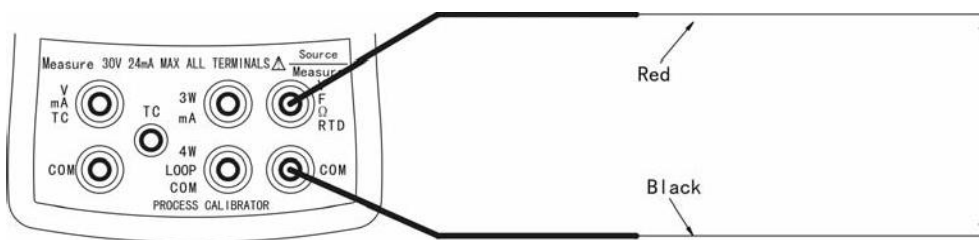







Figure6-4 Frequency Sourcing Connections

6.5 Simulating Thermocouples

To select Simulating Thermocouples function, proceed as follows:



- (1) Press  until the lower display shows "SOURCE".
- (2) Press  to select TC type. Continue pressing it to select the desired TC type.
- (3) Connect the test leads as shown in Figure6-5.
- (4) Enter the desired output value by pressing the numeric

keypads and press .

 CAUTION: Please pay attention to the current cold junction temperature, and if necessary, press  to adjust the cold junction temperature manually.

6.6 Simulating RTD

To select Simulate an RTD function, proceed as follows:

- (1) Press  until the lower display shows "SOURCE".
- (2) Press  to select RTD display. Continue pressing it to select the desired RTD type.
- (3) Connect the test leads as shown in Figure6-6.
- (4) Enter the desired output value by pressing the numeric

keypads and press .

 CAUTION: SUP825J Multi-function process calibrator can only simulate 2-wire connection.

CAUTION: Clear of RTD before simulating according to '10.4 Clear of Resistance and RTD'.

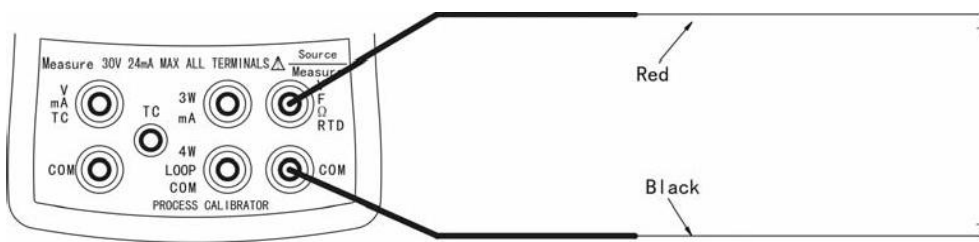

Figure6-5 Connections for Simulating a Thermocouple

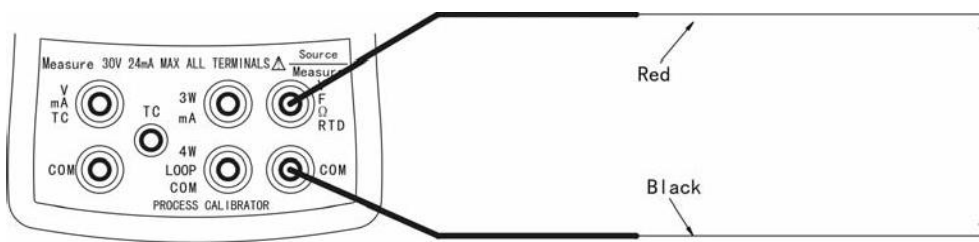



Figure6-6 Connections for Simulating an RTD



6.7 Ramping and Stepping the Output

Two ways are available for adjusting the value of source function.

- Stepping the output manually with  or numeric keypads;
- Auto ramping the output.

Auto ramping can be applied in all sourcing functions, which allow you to source a varying output from the SUP825J Multi-function process calibrator continuously.

When you press , the SUP825J Multi-function process calibrator produces a continuously repeating 0% ~ 100% ~ 0% ramp in your choice of three ramp waveforms:



-  0%~100%~0% 40 seconds smooth ramp;
-  0%~100%~0% 10 seconds smooth ramp;
-  0%—25%—50%—75%—100%—0%, stair-step ramp in 25% steps, pausing 25 seconds at each step.

Press any key to exit ramping.

6.8 Simulating Transmitter

The function of Simulating Transmitter is only applicable to SUP825J Multi-function process calibrator.

Proceed as follows to simulate transmitter:

- Press  until the display shows "SOURCE".
- Press  to select simulating transmitter until the display shows "LOOP mA". The SUP825J Multi-function process calibrator produces a variable resistance to regulate current to the specified value.
- Connect an external loop power supply as shown in Figure6-7.
- Enter the desired output value by pressing numeric keypads

and press .

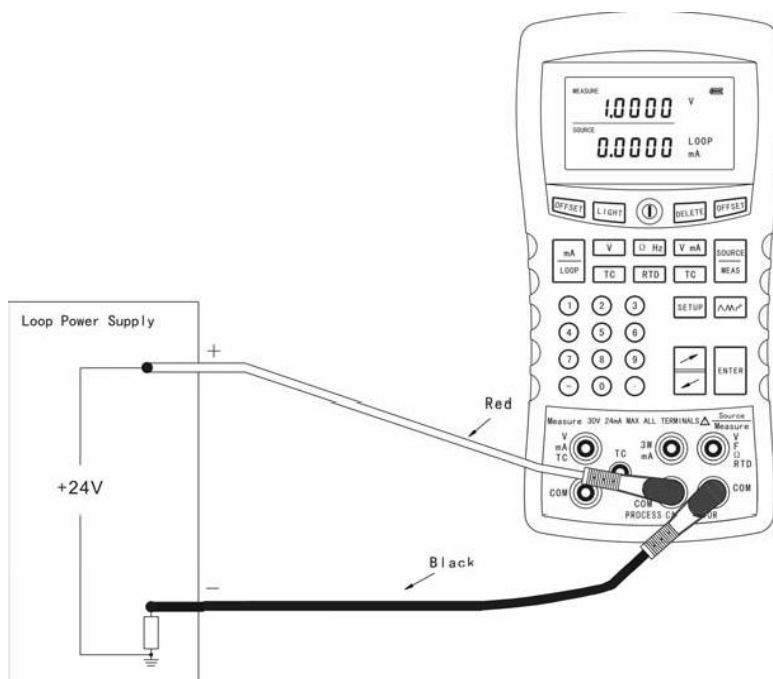

Figure6-7 Connections for Simulating a Transmitter

7 Cold Junction

Two modes are available for setting cold junction.

1) Automatic Mode

When you turn on the SUP825J Multi-function process calibrator, it is just in the automatic mode. At this mode, the SUP825J Multi-function process calibrator takes the temperature of jacks as cold junction temperature.

2) Manual Mode

(1) Press  until the display shows "SET COLD JUNC".

(2) Enter the desired cold junction temperature by pressing

numeric keys and press , the display shows "COLD JUNC OK".

(3) Press any key to exit the "SET COLD JUNC" mode.

8 Switching Temperature Unit

To switch temperature unit, proceed as follows:

Take switching °C to °F for example:

(1) Press  until the display shows "SET COLD JUNC".



(2) Press  until the display shows "°C TO°F".

(3) Using the same way to switch °F to °C.

(4) Press .

9 Calibration

SUP825J Multi-function process calibrator can only be calibrated by old hand.



-  CAUTION: The connections of calibration are the same as connections of using these parameters.
-  CAUTION: Clear offset of resistance or RTD before using to eliminate offset errors and test leads errors, according to '10.4 Clear of Resistance and RTD'.

9.1 Equipments Required

High-precision multimeter

High- Precision resistance box

9.2 Entry and Exit

(1) Press , then press  until the display shows "CAL".

(2) Press  until the display shows "ENTER PASS WORD", then press numeric keypads to enter password.

(3) When you press  to select the function, the upper display shows "CALIBRATE".

(4) Press  again to exit the Calibrate mode.

9.3 Calibration

For Measure jacks, DC voltage and current must be calibrated.

For Measurement with Source/Measure jacks, current, resistance of 2-, 3-, and 4-wire and. Cold junction must be calibrated

For Sourcing with Source/Measure jacks, VDC voltage, current and resistance must be calibrated.

9.3.1 Calibrating Sourcing

The following example shows how to calibrate V DC.

- (1) First of all, the SUP825J Multi-function process calibrator outputs DC ZERO. The display shows "0.0000V". When the output is stable, you should enter the exact output value. For example, if the measured voltage is 0.002V, press 0.002 in



the keypad and to end the DC ZERO calibrating.

- (2) Then let the SUP825J Multi-function process calibrator output full span (10V). When the output is stable, you should

enter the exact output value and press . The display shows "CAL V OK".



- (3) Press  to select to calibrate others terms, sourcing calibrating of others signal is similar to above.

When the SUP825J Multi-function process calibrator is in calibration, the span is divided into several segments in order to reach the maximal precision. For example, when sourcing resistance is calibrated, the span (0-3200) Ω is divided into five segments: (15-40) Ω , (40-400) Ω , (400-800) Ω , (800-1800) Ω and (1800-3200) Ω , and the calibration must be operated five times.

Table9-1 shows the calibrating points of Sourcing functions.

9.3.2 Calibrating Measurement

A steady signal generator is needed for measurement calibrating.

The following example shows how to calibrate mV DC measurement.

- (1) First of all, let the signal generator supply a steady value close to the zero point. Then the display shows "ZERO", the SUP825J Multi-function process calibrator will display approximation at the same time.
- (2) When the input is stable, you should enter the exact input value.
- (3) Then, let the SUP825J Multi-function process calibrator input full span (100mV) and the display shows "SCALE". After the input is stable, you should enter the exact input value and



press . The display shows "CAL mV OK".

Table9-2 shows the calibrating points of Measurement functions.

9.3.3 Calibrating Cold Junction

An accurate temperature measure instrument is needed for Cold Junction calibrating..

The following shows how to calibrate cold junction.

- (1) First of all, enter cold junction calibration mode. The display shows "CAL COLD JUNC".
- (2) Enter the exact value by pressing numeric keypads.



- (3) Press  until the display shows "CAL COLD OK" at the bottom-right corner.

 **CAUTION:** In general, Cold Junction is unnecessary due to the high-precision temperature sensor internal. If necessary, the temperature balance between the sensor and the ambient should be kept.

Table9-1 The Calibrating Points for Sourcing Functions

Source	Calibrating Point									
Zero	Span									
VDC	0V	10V	—	—	—	—	—	—	—	—
mVDC	0mV	100mV	—	—	—	—	—	—	—	—
mADC	1mA	20mA	—	—	—	—	—	—	—	—
Ω	15 Ω	40 Ω	40 Ω	400 Ω	400 Ω	800 Ω	800 Ω	1800 Ω	1800 Ω	3200 Ω

Table9-2 The Calibrating Points for Measurement Functions

Measure	Zero	Span
Source/Measure VDC	1V	20V
Source/Measure mVDC	1mV	100mV
Source/Measure Ω	0 Ω	400 Ω
	500 Ω	3000 Ω
Measure VDC	0.1V	20V
Measure mVDC	1mV	100mV
Measure mADC	0.1mA	20mA

10 Clear Function

Before sourcing or measuring DC voltage, resistance, RTDS and TC, offset errors caused by internal elements or external factors must be cleared.

i CAUTION: The cleared values will be invalid at power on, except sourcing resistance and RTDs.

i CAUTION: The cleared range as follows:

V (-10mV~+10mV),

mV and TC (-50 μ V~+50 μ V),

Resistance and RTD (-10 Ω ~+10 Ω).

10.1 Clear of Measuring Voltage

Clear of Measuring V DC in upper display:

Press **V** until the upper display shows "V". Short the test leads with Measure jacks and press left **OFFSET**.

Clear of Measuring mV DC in upper display:

Press **V** until the upper display shows "mV". Short the test leads with Measure jacks and press left **OFFSET**.

Clear of Measuring V DC in lower display:

Press **V mA** until the upper display shows "V". Short the test leads with Source/Measure jacks and press right **OFFSET**.

Clear of Measuring mV DC in lower display:

Press **V mA** until the upper display shows "mV". Short the test leads with Source/Measure jacks and press right **OFFSET**.

10.2 Clear of Sourcing Voltage

To clear offset of sourcing V DC, proceed as follows:

- (1) Clear of V DC in upper display according to '10.1 Clear of Measuring Voltage'.

- (2) Press  to select Source mode.

- (3) Press  until the lower display shows "V".

- (4) Connect the SUP825J Multi-function process calibrator's voltage output to its voltage input according to the flashing jacks as Figure3-1 shows.

- (5) Press right  after the value is stable.

To clear offset of sourcing mV DC, proceed as follows:

- (1) Clear of mV DC in upper display according to '10.1 Clear of Measuring Voltage'.

- (2) Press  to select Source mode.



- (3) Press  until the lower display shows "mV".

- (4) Connect the SUP825J Multi-function process calibrator's voltage output to its voltage input according to the flashing jacks as Figure3-1 shows.



- (5) Press right  after the value is stable.

10.3 Clear of Measuring with TC

To clear offset of measuring temperature with TC in the upper display, proceed as follows:

- (1) Press left  to select the decided TC.
- (2) Short the test leads with Measure jacks.
- (3) Press left  after the value is stable.



To clear offset of measuring temperature with TC in the lower display, proceed as follows:

- (1) Press right  to select the decided TC.
- (2) Short the test leads with Measure jacks.
- (3) Press right  after the value is stable.



10.4 Clear of Resistance and RTDs

To clear offset associated with the test lead resistance in 2-wire, 3-wire or 4-wire ohms measurements, proceed as follows:

To clear offset of measuring or sourcing resistance, proceed as follows:

- (1) Press  to select Measure or Source mode.
- (2) Press  to select the decided resistance.
- (3) Short the test leads with Measure or Source jacks.
- (4) Press right  after the value is stable

To clear offset of measuring or sourcing RTD, proceed as follows:

- (1) Press  to select Measure or Source mode.
- (2) Press  to select the decided RTD.
- (3) Short the test leads with Measure or Source jacks.

- (4) Press right **OFFSET** after the value is stable.

10.5 Clear of Sourcing TC

To clear offset of sourcing TC must be according to '10.2 Clear of Sourcing Voltage'.

11 Calibrating a Transmitter

Use Measure mode (upper display) and Source mode (lower display) to calibrate the transmitter.

Proceed as follows to take calibration of a transmitter.

- (1) Press **mA**/**LOOP** until the upper display shows "MEASURE LOOP".

- (2) Press **SOURCE**/**MEAS** until the lower display shows "SOURCE".

- (3) Press right **TC** to select a desired TC type.

- (4) Connect the test leads as shown in Figure 11-1.

- (5) Press **↗**/**↘** or numeric keypads to output the zero and span parameter.

41

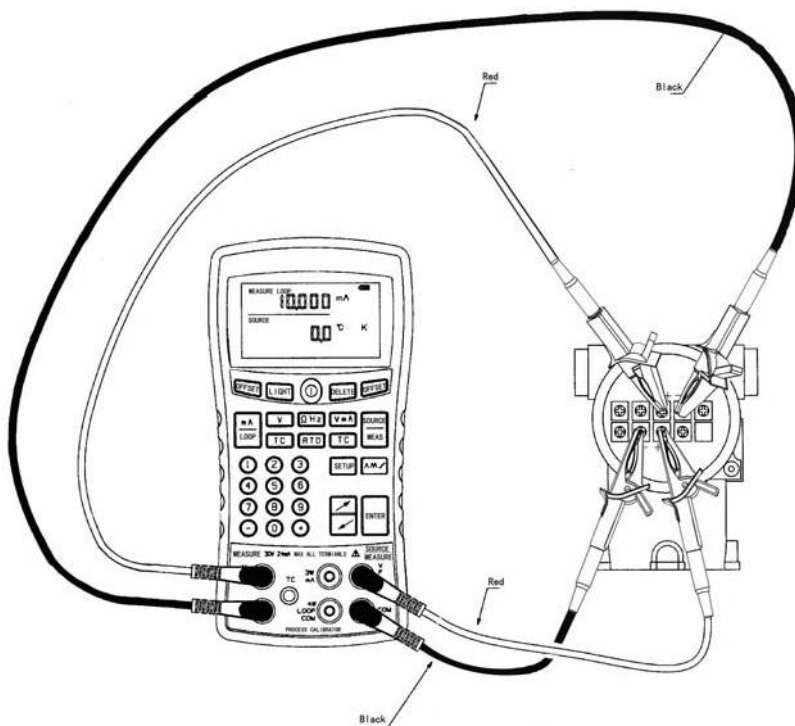
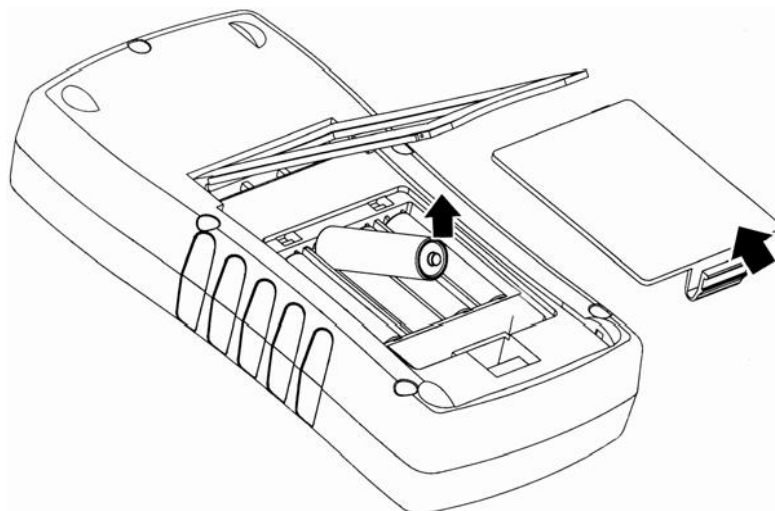

Figure 11-1 Adjusting the Transmitter

12 Maintenance

Replace the batteries as follows:



43

13 Specifications

All specifications apply from +18°C to +28°C unless stated otherwise. All specifications assume a 5-minute warm-up period. Temperature coefficient from -10°C to +18°C and +28°C to 55°C is $\pm 0.005\%/^{\circ}\text{C}$ of range per $^{\circ}\text{C}$.

All specifications are not based on clearing except resistance and RTDs. To achieve higher accuracy, please perform clear function to eliminate offset errors.

Maximum Input Voltage: 30V.

DC Voltage	Range	Accuracy
Measurement	(0~100)mVDC(Upper display)	$\pm 0.02\%$
	(0~30)VDC(Upper display)	$\pm 0.02\%$
	(0~100)mVDC(Lower display)	$\pm 0.02\%$
	(0~20)VDC(Lower display)	$\pm 0.02\%$
Source	(0~100)mVDC	$\pm 0.02\%$
	(0~10)VDC	$\pm 0.02\%$

Resistance	Range	Accuracy	
		4-wire	2-, 3-wire
		Accuracy	Accuracy
Measurement	(0~400) Ω	$\pm 0.1\Omega$	$\pm 0.15\Omega$
	(0.4~1.5)k Ω	$\pm 0.5\Omega$	$\pm 1.0\Omega$
	(1.5~3.2)k Ω	$\pm 1.0\Omega$	$\pm 1.5\Omega$
	Excitation Current: 0.5mA Clear of resistance before measuring according to '10.4 Clear of Resistance and RTDs'. *3-wire: Assumes matched leads with a total resistance not exceeding 100 Ω . Resolution (0~1000) Ω : 0.01 Ω ; (1.0~3.2)k Ω : 0.1 Ω .		
Source	Range	Excitation Current from Measurement Device	Accuracy
	(15~400) Ω	(0.15~0.5)mA	$\pm 0.15\Omega$
	(15~400) Ω	(0.5~3)mA	$\pm 0.1\Omega$
	(0.4~1.5)k Ω	(0.05~0.8)mA	$\pm 0.5\Omega$
	(1.5~3.2)k Ω	(0.05~0.4)mA	$\pm 1.0\Omega$
	Clear of resistance before sourcing according to '10.4 Clear of Resistance and RTDs'.		

45

Frequency	Range	Accuracy
Measurement	(1~1100)Hz	$\pm 0.05\%$
	(1.0~10.0)kHz	$\pm 0.05\%$
	Sensitivity: Not less than 1V (peak- peak) Wave form: Square wave	
Source	(1~1100)Hz	$\pm 0.05\%$
	(1.0~5.0)kHz	$\pm 0.05\%$
	Wave form: (0~8)V (peak-peak) Load drive capability: 3mA	

DC Current	Range	Accuracy
Measurement	(0~24)mADC	$\pm 0.02\%$
Source	(0~24)mADC	$\pm 0.02\%$

Thermocouple (TC)	Type	Range	Measure and Source Accuracy (When Cold Junction temperature is 0°C)	
			Measure	Source
	J	(-200~0)°C	±0.8°C	
		(0~1200)°C	±0.5°C	
	K	(-200~0)°C	±1.0°C	
		(0~1370)°C	±0.6°C	
	T	(-200~0)°C	±1.0°C	
		(0~400)°C	±0.6°C	
	E	(-100~0)°C	±0.7°C	
		(0~950)°C	±0.5°C	
	R	(-20~0)°C	±2.3°C	
		(0~500)°C	±1.6°C	
		(500~1750)°C	±1.2°C	
	S	(-20~0)°C	±2.3°C	
		(0~500)°C	±1.6°C	
		(500~1750)°C	±1.3°C	
	B	(600~800)°C	±2.0°C	
		(800~1000)°C	±1.6°C	
		(1000~1800)°C	±1.2°C	
	N	(-200~0)°C	±1.3°C	
(0~1300)°C		±0.7°C		

Resolution :
 J, K, T, E, N: 0.1°C
 B, R, S: 1°C
 Cold junction error: ±0.5°C, does not including sensor error.

47

Type	Range (°C)	Accuracy		
		Measure 4-wire (°C)	Measure 2-, 3- (°C)	Output (°C)
Cu50	(-50~150) °C	±1.2°C	±2.0°C	±1.2°C
Pt100(385)	(-200~800) °C	±0.6°C	±1.0°C	±0.6°C

Resolution: 0.1°C
 Excitation Current (Source): Cu50, Pt100(385), Pt100(3916), Pt200(385): (0.15~3.0)mA;
 Pt500(385): (0.05~0.80)mA; Pt1000(385): (0.05~0.40)mA.
 Clear of RTD before measuring or sourcing according to '10.4 Clear of Resistance and RTDs'.
 *3-wire: Assumes matched leads with a total resistance not exceeding 100Ω.

General Specifications	Operating temperature	-10°C~55°C
	Storage temperature	-20°C~70°C
	Relative Humidity (%RH operating without condensation)	90%(10°C~30°C)
		75%(30°C~40°C)
		45%(40°C~50°C)
		35%(50°C~55°C)
		Uncontrolled <10°C
	EMC	EN55022, EN55024
	Vibration	Random, 2g, 5 to 500Hz
	Concussion	30g, 11ms, half sine bow wave
	Power requirement	4 AA Ni-MH, Ni-Cd batteries
	Size	215mm×109mm×44.5mm
Weight	About 500g	

14 Optional Parts

The optional parts list:

- Alligator clips (one set)
- Test Probes (one set)
- Test leads (one set)
- 4 AA Rechargeable batteries
- Battery charger
- Leather case